



I Application

The INNOVA N-type valve is a pneumatic shut-off seat valve for hygienic applications.

I Design and features

Hygienic design according to EHEDG.

Gasket with specific profile guarantees reliability under adverse working conditions.

Hygienic design of the gasket ensures optimal cleaning.

Single-acting pneumatic actuator.

Normally closed valve (NC).

The valve can be changed to normally open (NO) by simply reversing the position of the pneumatic actuator.

Easy assembly/disassembly of internal parts by loosening a clamp fastener.

Open lantern allows visual inspection of shaft sealing.

360° adjustable body.

The valve is authorized to carry 3-A symbol.

Note: Consult the options of the valves authorized to carry 3-A symbol.



Standard Number 53-06

I Technical specifications

Materials:

Parts in contact with the product AISI 316L (1.4404)

Other stainless steel parts AISI 304 (1.4301)

Gasket EPDM

Surface finish:

Internal Bright polish Ra ≤ 0,8 µm

External Matt

Available sizes:

DIN 11850 DN 25 - DN 100

ASME BPE OD 1" - OD 4"

Connections

Weld

Operating limits:

Temperature range -10 °C to+ 121 °C (EPDM) 14 °F to 250°F

+140 °C (SIP, max. 30 min) 284 °F

Maximum working pressure 10 bar 145 PSI

Minimum working pressure Vacuum Vacuum

Compressed air pressure 6-8 bar 87-116 PSI

I Options

Double-acting pneumatic actuator.

Gaskets: FPM, HNBR.

Other connection types.

Control unit: C-TOP and C-TOP+.

External position sensors.

Surface finish: Ra ≤ 0,5 µm.



I Housing combinations

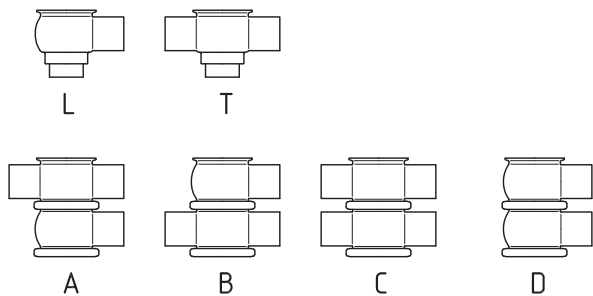

I Dimensions

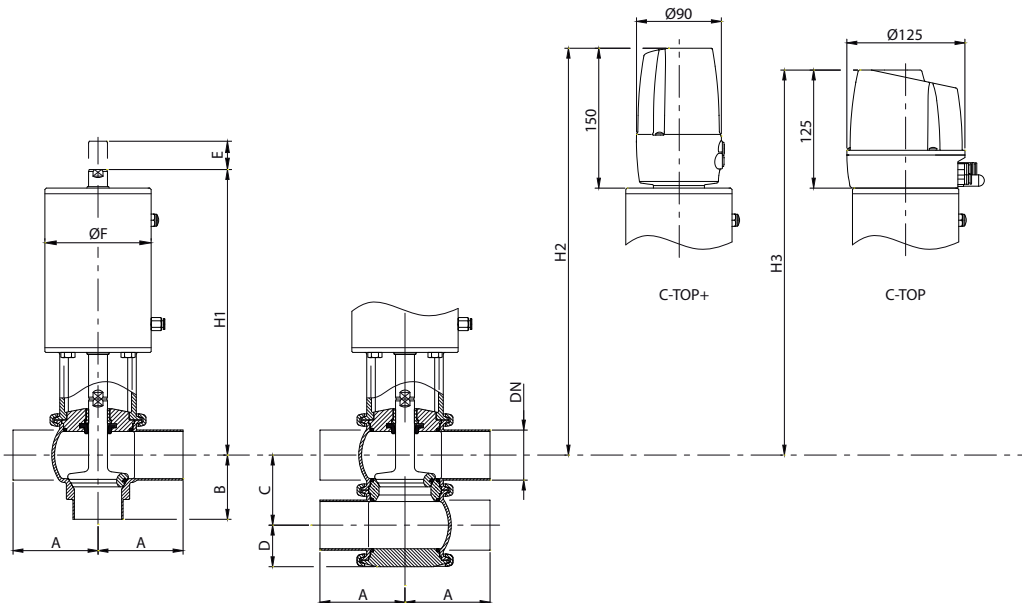



	DN	Pipe Ø	A	B	C	D	Ø F	E	H ₁	H ₂	H ₃	kg
DIN	25	29 x 1,5	50	50	50	32	87	17	239	367	342	4,6
	40	41 x 1,5	85	60	62	38	87	24	240	377	352	5,3
	50	53 x 1,5	90	68	74	44	112	31	302	433	408	9,1
	65	70 x 2,0	110	81	92	53	143	37	348	485	460	16
	80	85 x 2,0	125	90	107	60	143	37	355	492	467	17
	100	104 x 2,0	150	125	127	70	216	34	383	516	491	33
OD	1"	25,4 x 1,65	50	50	46	30	87	13	241	369	344	4,6
	1½"	38,1 x 1,65	85	60	59	36	87	20	242	379	354	5,3
	2"	50,8 x 1,65	90	68	72	43	112	28	304	434	409	9,1
	2½"	63,5 x 1,65	110	81	86	50	143	32	351	488	463	16
	3"	76,2 x 1,65	125	90	99	56	143	29	359	496	471	17
	4"	101,6 x 2,11	150	125	124	69	216	31	384	517	492	33



*The weights correspond to the "L" housing combination.

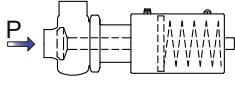

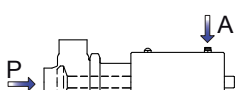
Maximum pressure in bar / PSI without leakage at the valve seat.

Actuator/valve body combination and direction of pressure	Air pressure	Plug position	OD 1"	OD 1½"	OD 2"	OD 2½"	OD 3"	OD 4"
	[bar] / [PSI]		DN 25	DN 40	DN 50	DN 65	DN 80	DN 100
	6 / 87	NC	10 / 145	6 / 87	5,5 / 79	5,5 / 79	4,5 / 65	5 / 72
	6 / 87	NO	10 / 145	9 / 130	6 / 87	6,5 / 94	5,5 / 79	10 / 145
	6 / 87	A/A	10 / 145	10 / 145	10 / 145	10 / 145	10 / 145	10 / 145

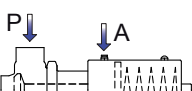
Maximum pressure in bar / PSI against which the valve can open.

Actuator/valve body combination and direction of pressure	Presión aire	Posición obturador	OD 1"	OD 1½"	OD 2"	OD 2½"	OD 3"	OD 4"
	[bar] / [PSI]		DN 25	DN 40	DN 50	DN 65	DN 80	DN 100
	6 / 87	NC	10 / 145	10 / 145	10 / 145	9,5 / 137	8,5 / 123	10 / 145
	6 / 87	NO	10 / 145	7,5 / 108	10 / 145	9 / 130	10 / 145	6 / 87

A = Air
 P = Product pressure
 NC = Normally closed
 NO = Normally open
 A/A = Double acting

Note: Values for standard actuators.
 For other pressures, bigger actuators can be assembled.

